

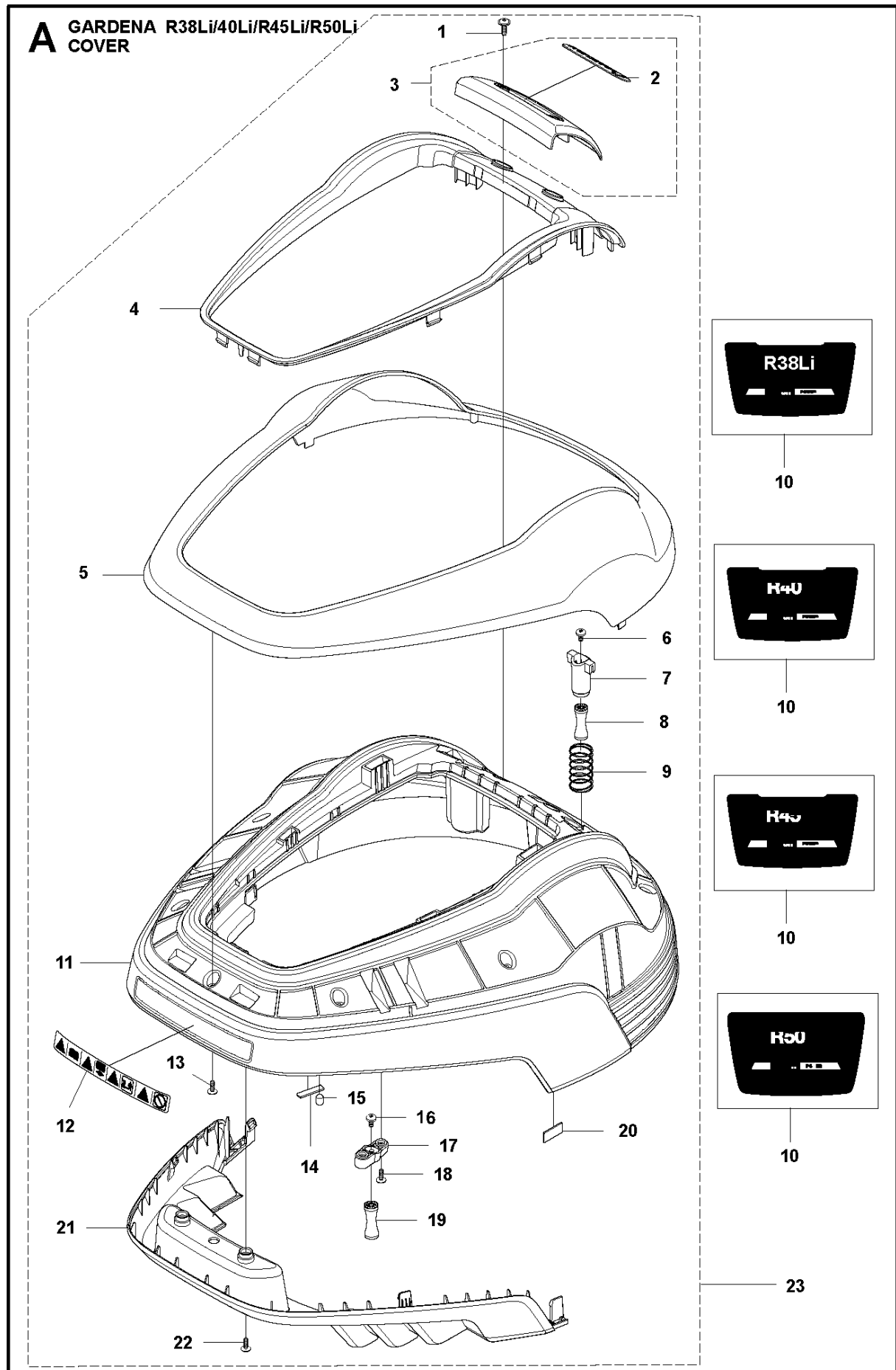

SPARE PARTS LIST

ROBOTIC LAWN MOWERS

R38Li, 2017-01



Ref	Artikelnr	Beskrivning	Anmärkning	ANT SATS AL
1	575 54 33-14	SCREW	Screw, Grey (14 mm)	2
2	510 31 03-01	LOGOTYP	Decal, Gardena Logotype	1
3	579 39 21-05	PLATE KIT	Logo, Plate KIT incl. Logo	1
4	577 70 76-04	RAM	Frame	1
5	577 70 73-04	KÅPA	Cover	1
6	576 21 39-01	SKRUV ITXPANM	Screw	2
7	574 46 90-02	FÄSTE	Bracket, Lift Sensor	2
8	574 46 91-02	DAMPER	Rubber Damper	2
9	574 48 51-02	FJÄDER	Spring, Lift Sensor	2
10	587 04 35-03	DEKAL	Decal, R38Li	1
10	580 92 80-01	DEKAL	Decal, R40Li	1
10	581 96 66-01	DEKAL	Decal, R45Li	1
10	587 04 35-01	DEKAL	Decal, R50Li	1
11	579 39 17-02	KIT	Main Body	1
12	586 35 97-01	DEKAL	Warning Label	1
13	575 54 33-14	SCREW	Screw, Grey (14 mm)	7
14	576 03 01-01	PLATTA	Plate, Collision Sensor	1
15	576 18 33-01	MAGNET	Magnet, Collision Sensor	1
16	576 21 39-01	SKRUV ITXPANM	Screw	2
17	575 41 60-02	SUPPORT CLAMP	Support Clamp	2
18	575 54 33-14	SCREW	Screw, Grey (14 mm)	4
19	574 46 91-02	DAMPER	Rubber Damper	2
20	576 18 32-02	MAGNET	Magnet, Lift Sensor	1
21	577 70 65-02	STÖTFÅNGARE	Bumper, Rear	1
22	575 54 33-14	SCREW	Screw, Grey (14 mm)	2
23	577 95 53-11	BODY SYSTEM	Cover KIT, Complete excl. Model Decal	1

B GARDENA R38Li/40Li/R45Li/R50Li
CHASSIS UPPER

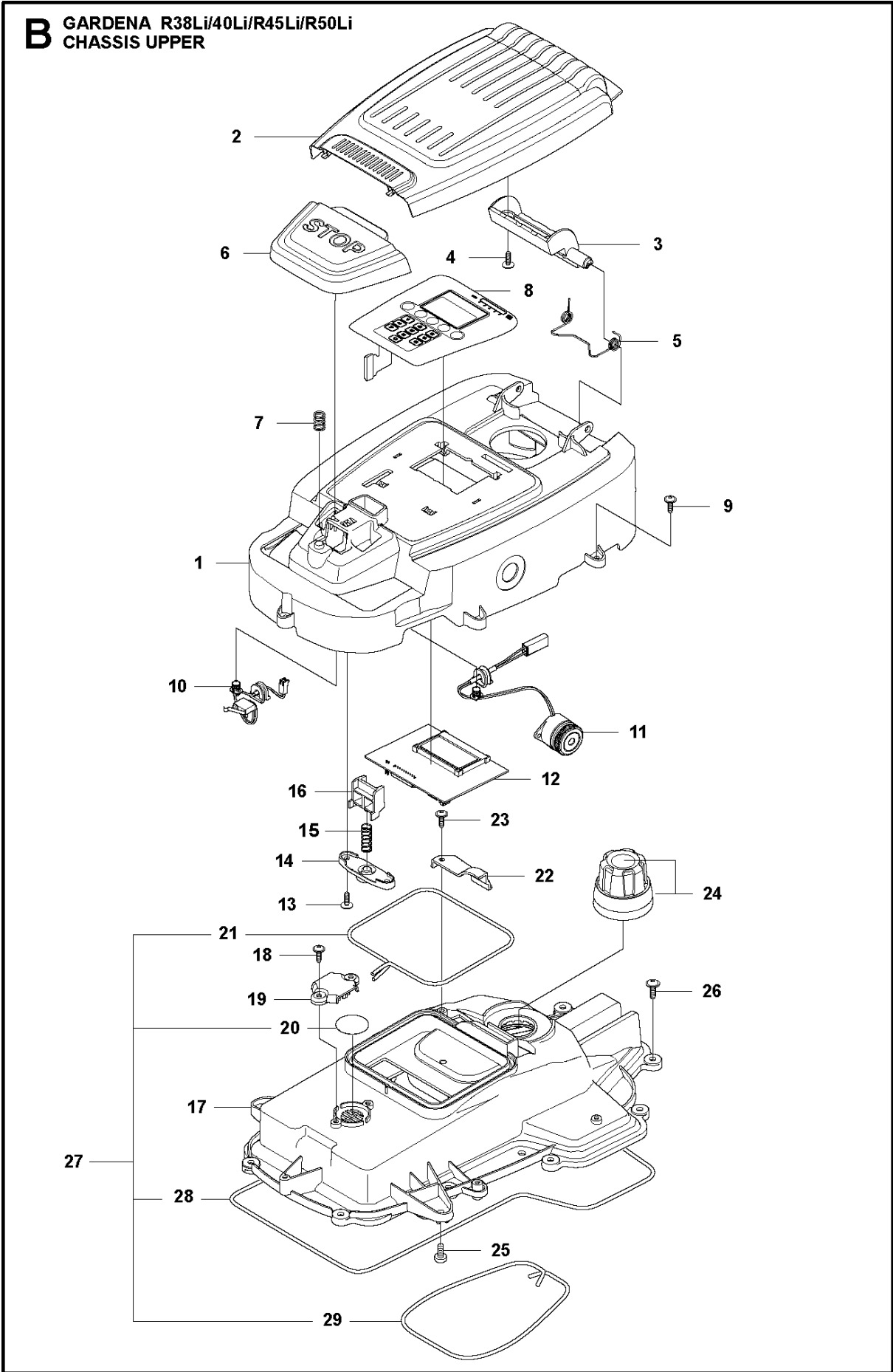

Ref	Artikelnr	Beskrivning	Anmärkning	ANT SATS AL
1	579 39 19-03	TÄCKLOCKSSATS	Display Cover KIT incl. Sealing & Keyboard	1
2	577 70 72-03	KÅPA	Cover, Height Adjustment	1
3	577 70 78-01	GÅNGJÄRN	Hinge, Height Adjustment Lid	1
4	575 54 33-14	SCREW	Screw, Grey (14 mm)	2
5	578 44 52-01	FJÄDER	Spring, Height Adjustment Lid	1
6	577 70 66-01	KNAPP	Stop Button	1
7	574 48 70-01	FJÄDER	Spring, Stop Button	1
8	586 94 56-01	TANGENTBORD	Keyboard	1
9	575 54 33-14	SCREW	Screw, Grey (14 mm)	5
10	574 48 03-01	BRYTARE	Micro Switch, Stop Button	1
11	574 47 59-01	BUZZER	Buzzer, Display Cover	1
12	588 44 19-01	KRETSKORT	Display/MMI, Circuit Board	1
13	575 54 33-14	SCREW	Screw, Grey (14 mm)	2
14	575 41 58-01	FJÄDERHÅLLARE	Spring Holder, Stop Button	1
15	576 24 22-01	FJÄDER	Spring Lock, Stop Button	1
16	575 40 90-01	LÅS	Lock, Stop Button	1
17	579 39 20-02	KIT	Chassis Upper KIT incl. Sealing & Air Filter	1
18	575 54 33-14	SCREW	Screw, Grey (14 mm)	2
19	576 69 70-01	KÅPA	Cover, Air Filter	1
20	577 75 37-01	KIT	Air Filter KIT (10 pcs)	1
21	574 87 47-04	TÄTNINGSLIST	Sealing Strip (1 pcs, 4 mm)	1
22	576 05 39-01	KÅPA	Cover, Height Indicator	1
23	575 54 33-14	SCREW	Screw, Grey (14 mm)	1
24	579 39 22-01	KIT	Knob, Height Adjustment KIT incl. Knob & Sticker	1
25	576 21 39-01	SKRUV ITXPANM	Screw	2
26	574 45 01-01	SKRUV ITXPANT	Screw	10
27	588 40 70-01	SEAL KIT	Seal KIT incl. Sealing Strip Chassis (1 pcs), Sealing Strip Short (2 pcs), Air Filter (1 pcs)	1
28	574 87 47-03	TÄTNINGSLIST	Sealing Strip, Chassis (1 pcs, 4 mm)	1
29	574 87 47-04	TÄTNINGSLIST	Sealing Strip (1 pcs, 4 mm)	1

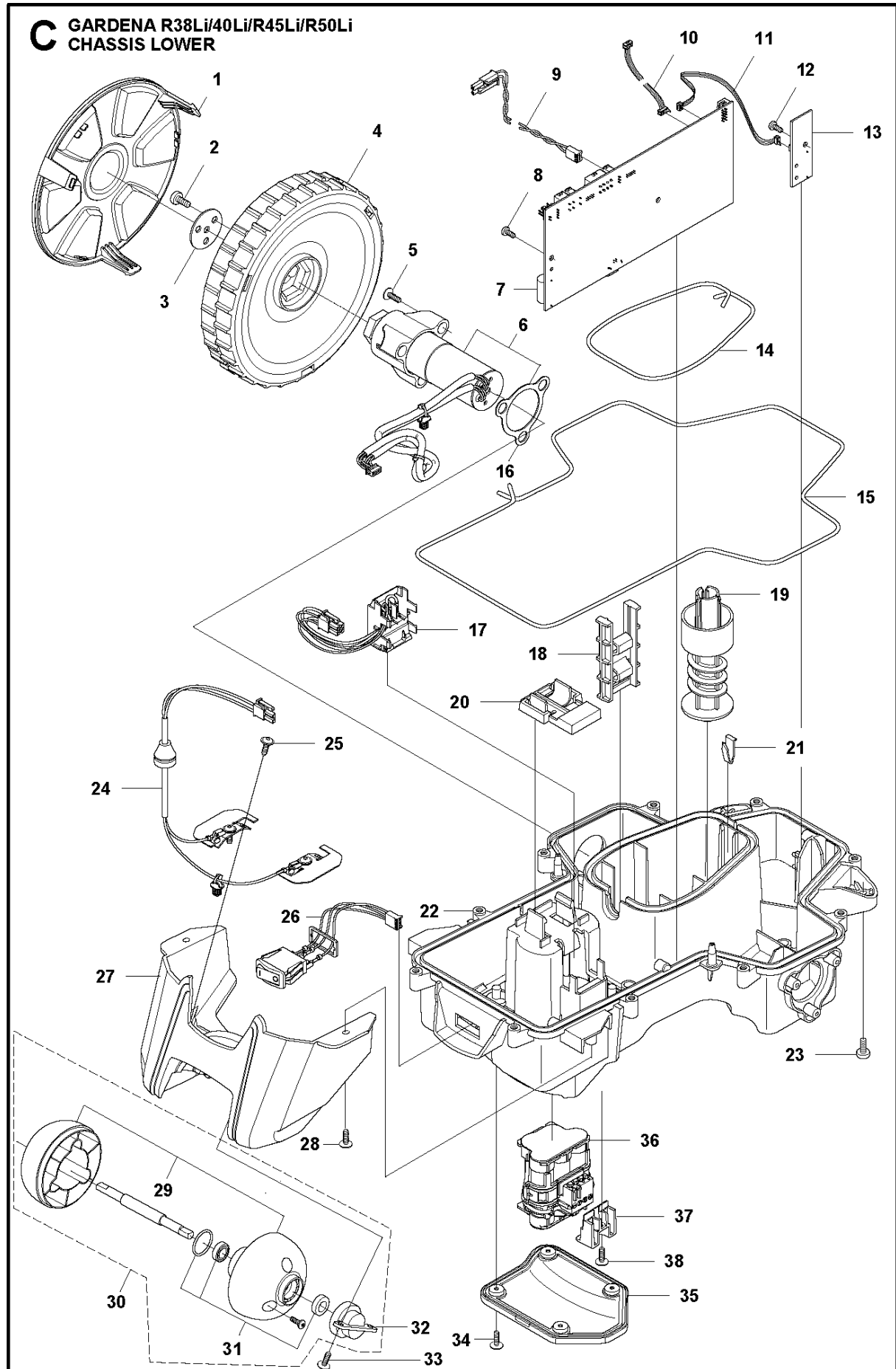

Ref	Artikelnr	Beskrivning	Anmärkning	ANT SATS AL
1	577 70 79-01	NAVKAPSEL	Hub Cap, Drive Wheel	2
2	576 21 39-02	SKRUV ITXPANM	Screw	6
3	577 09 32-01	BRICKA	Washer, Drive Wheel	2
4	574 46 51-04	HJUL	Wheel, Drive Wheel	2
5	575 54 33-14	SCREW	Screw, Grey (14 mm)	6
6	577 83 99-04	WHEEL MOTOR ASSY	Wheel Motor KIT incl. Sealing	2
7	588 62 88-03	KRETSKORT	Main Circuit Board (MCB)	1
8	535 13 03-10	SKRUV ITXPANT	Screw (10 mm)	2
9	576 22 02-01	LOOM	Loom, Buzzer Extension	1
10	588 83 27-01	KABLAGE KPL	Loom, Display	1
11	588 90 12-01	KABLAGE KPL	Loom, Loop and Lift Sensor	1
12	535 13 03-10	SKRUV ITXPANT	Screw (10 mm)	1
13	588 57 21-01	KRETSKORT	PCB Sensor Board	1
14	574 87 47-04	TÄTNINGSLIST	Sealing Strip (1 pcs, 4 mm)	1
15	574 87 47-03	TÄTNINGSLIST	Sealing Strip, Chassis (1 pcs, 4 mm)	1
16	574 37 37-01	PACKNING	Sealing/Gasket, Motor Flange	2
17	574 47 98-01	LOOM	Loom, Li-Ion Battery	1
18	574 50 19-01	STYRSKENA	Guide Rail, Motor Bowl	2
19	574 48 46-01	SCREW	Height Adjustment Screw	1
20	575 40 82-01	LÅS	Lock, Battery Plug	1
21	577 10 32-01	LÅSFJÄDER	Locking Spring	1
22	577 84 62-03	CHASSI	Chassis Lower KIT, incl. Sealing	1
23	576 21 39-01	SKRUV ITXPANM	Screw	2
24	588 95 09-01	KABLAGE KPL	Loom, Charge Plate	1
25	575 52 95-02	SKRUV ITXPANTT	Screw, Grey (14 mm)	2
26	579 70 87-01	KABLAGE KPL	Swith ON/OFF With Seal	1
27	574 46 72-02	HUS	Housing, Rear Wheel	1
28	575 54 33-14	SCREW	Screw, Grey (14 mm)	3
29	583 85 39-02	BAKHJUL	Rear Wheel KIT	1
30	578 27 51-03	BAKHJUL	Rear Wheel KIT Complete	1
31	578 27 52-01	BAKHJUL	Bearing (X2), Sealing (X2), O-Ring (X1)	1
32	577 71 50-01	LAGERHUS	Bearing Housing, Rear Wheel	2
33	575 54 33-14	SCREW	Screw, Grey (14 mm)	4
34	574 45 01-01	SKRUV ITXPANT	Screw	4
35	574 46 73-01	KÅPA	Cover, Battery	1
36	586 57 62-01	BATTERI	Battery, Lithium 18 v	1
37	582 38 61-01	FÄSTE	Bracket	1
38	575 54 33-14	SCREW	Screw, Grey (14 mm)	1

D GARDENA R38Li/40Li/R45Li/R50Li
BLADE MOTOR & CUTTING EQUIPMENT

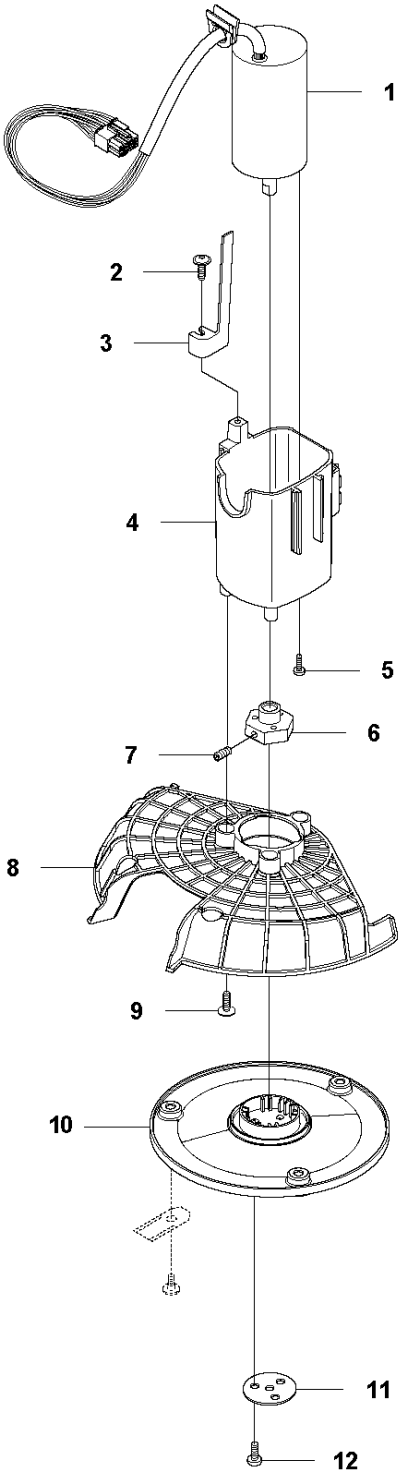

Ref	Artikelnr	Beskrivning	Anmärkning	ANT SATS AL
1	584 98 93-02	MOTOR	Cutting Motor	1
2	575 54 33-10	SCREW	Screw, Grey (10 mm)	1
3	574 50 35-01	HEIGHT INDICATOR	Height Indicator	1
4	581 02 03-01	MOTORHUS	Motor Housing	1
5	576 21 38-01	SKRUV ITXPANM	Screw M4x12	3
6	574 37 35-01	NAV	Hub, Cutting Motor	1
7	576 21 35-01	SKRUV IHSETM	Stop Screw	1
8	579 75 83-01	SKYDD	Guard, Cutting Disc	1
9	575 54 33-14	SCREW	Screw, Grey (14 mm)	3
10	574 48 71-01	KNIVDISK	Cutting Disc	1
11	577 09 32-01	BRICKA	Washer	1
12	576 21 38-01	SKRUV ITXPANM	Screw	3

E GARDENA R38Li/40Li/R45Li/R50Li
CHARGING STATION

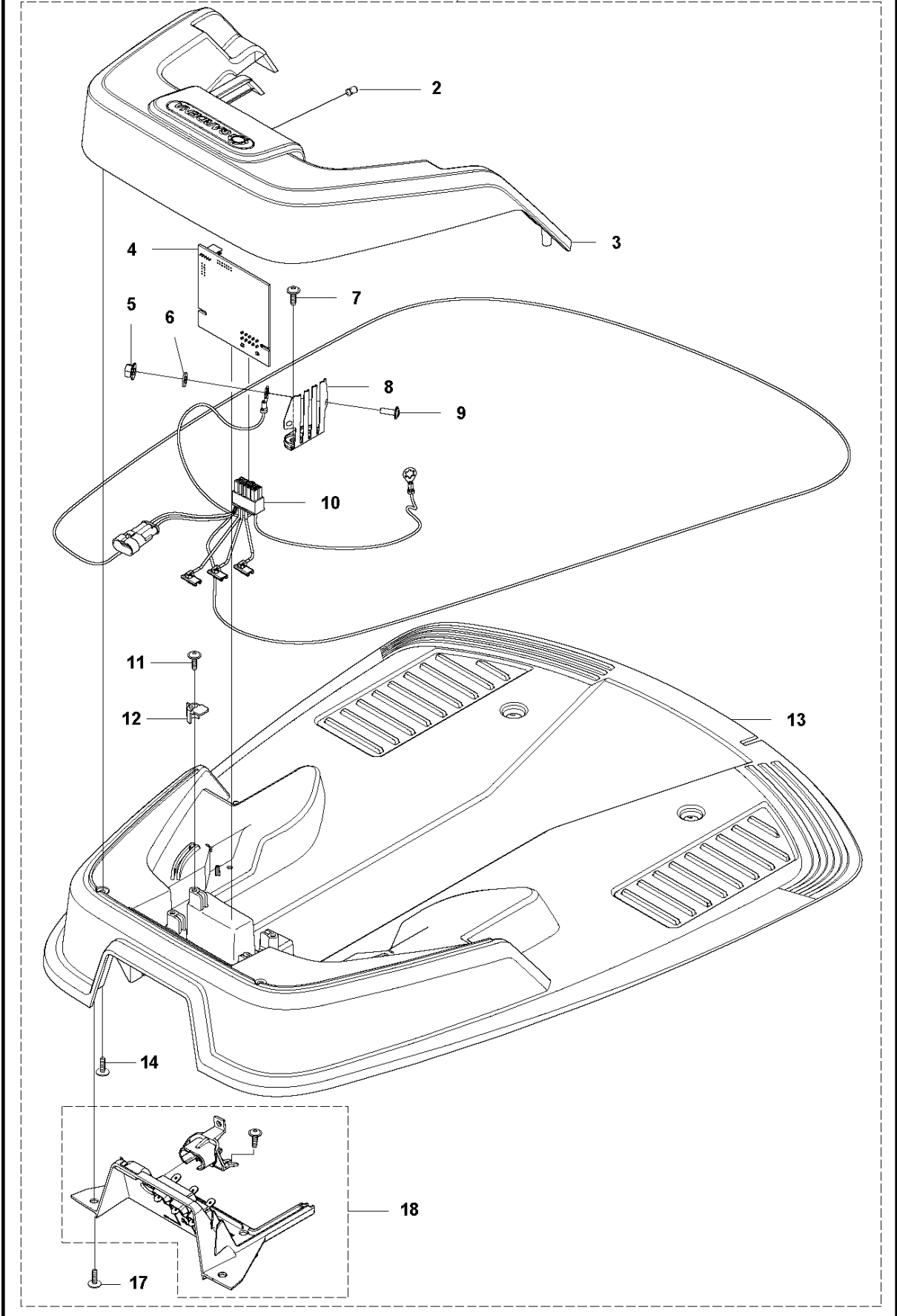

Ref	Artikelnr	Beskrivning	Anmärkning	ANT SATS AL
1	577 97 23-15	LADDSTATION	Charging Station, Gardena	1
2	535 12 87-02	DIODLINS	Diode Lens	1
3	584 61 83-02	LADDSTATION	Charging Station Cover, Gardena	1
4	582 87 62-01	KRETSKORT	Circuit Board, Charging Station	1
5	588 22 21-01	HEXAGON NUT FLANGE	Nut Flange	2
6	535 08 74-01	BRICKA	Washer	2
7	575 54 33-14	SCREW	Screw, Grey (14 mm)	2
8	587 12 51-01	KONTAKT	Contacts, Charging Station	2
9	588 22 22-01	SKRUV ITXPANM	Screw	2
10	582 38 10-01	KABLAGE KPL	Loom, Charging Station	1
11	575 54 33-14	SCREW	Screw, Grey (14 mm)	2
12	535 12 79-01	FÄSTE	Bracket	2
13	581 55 19-03	LADDSTATION	Charging Station Base Plate	1
14	575 54 33-14	SCREW	Screw, Grey (14 mm)	4
17	575 54 33-14	SCREW	Screw, Grey (14 mm)	4
18	582 35 64-01	PANEL ASSY	Guide Cover, Charging Station	1

F GARDENA R38Li/40Li/R45Li/R50Li
INSTALLATION ACCESSORIES

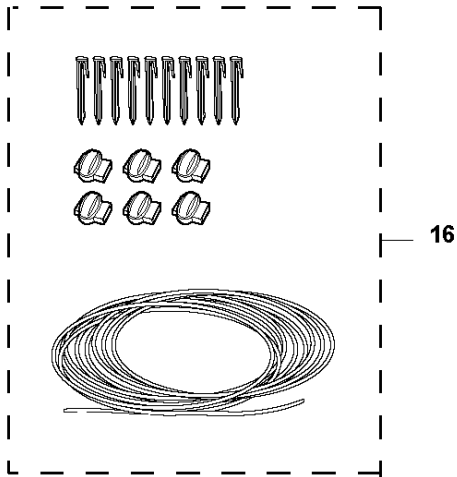
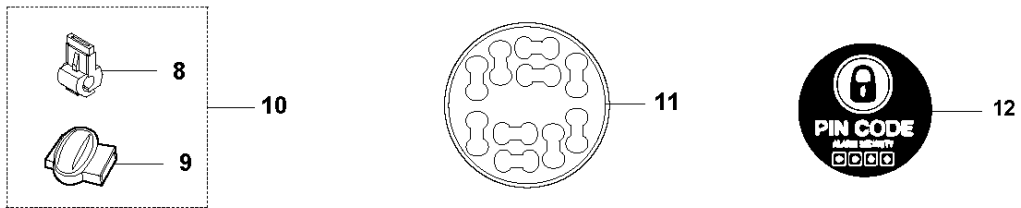
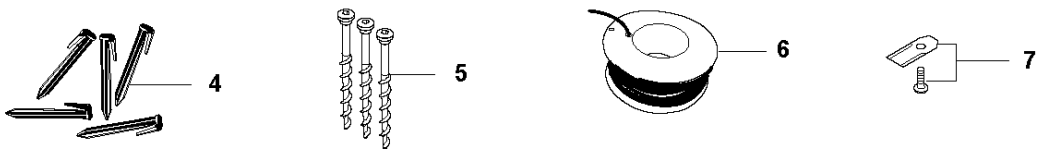
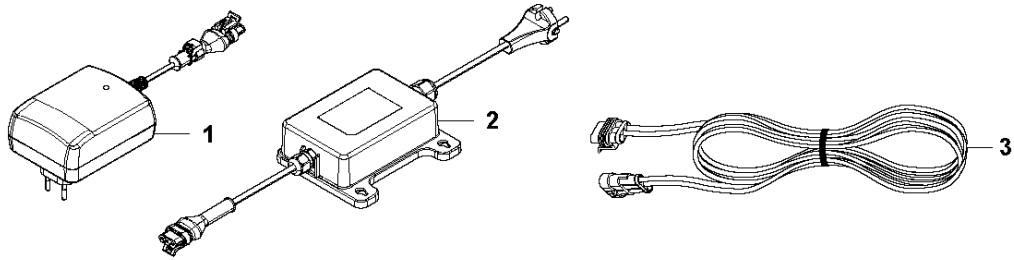

Ref	Artikelnr	Beskrivning	Anmärkning	ANT SATS AL
1	584 86 25-01	DRIVENHET	Power Supply Unit, EU	1
2	584 86 26-02	DRIVENHET	Power Supply Unit, UK	1
2	584 86 26-03	DRIVENHET	Power Supply Unit, CH	1
2	584 86 26-04	DRIVENHET	Power Supply Unit, CA	1
2	584 86 26-05	DRIVENHET	Power Supply Unit, AU-NZ	1
3	579 82 51-01	KABLAGE KPL	Low Voltage Cable (20 m)	1
3	579 82 51-02	KABLAGE KPL	Low Voltage Cable (10 m)	1
3	579 82 51-03	KABLAGE KPL	Low Voltage Cable (3 m)	1
4	966 80 98-01	KLAMMER	Staples (100 pcs), Gardena Blister Pack	1
4	Gardena40902 0	TBD	Staples (100 pcs), Gardena Blister Pack	1
5	575 23 86-02	SCREW KIT	Anchor Screw (3 pcs) incl. Allen Key	1
6	967 10 48-01	VAJER	Loop Wire 50 m, Gardena Blister Pack	1
6	Gardena40582 0	TBD	Loop Wire 50 m, Gardena Blister Pack	1
6	966 80 96-01	VAJER	Loop Wire (150 m), Gardena Blister Pack	1
6	Gardena40882 0	TBD	Loop Wire (150 m), Gardena Blister Pack	1
7	966 80 95-01	KNIV	Blades (9 pcs), Gardena Blister Pack	1
7	Gardena40872 0	TBD	Blades (9 pcs), Gardena Blister Pack	1
7	577 60 65-05	BLADE SET	Long Life - Safety Blade, 45 pcs	1
7	577 60 66-04	BLADE SET	Long Life - Safety Blade, 300 pcs	1
8	535 12 90-01	KOPPLING	Loop Wire Connector (1pcs)	1
9	501 98 02-01	KOPPLING	Coupler (1pcs)	1
9	501 98 02-02	KOPPLING	Coupler KIT (50pcs)	1
10	966 80 97-01	KOPPLING	2 Connectors+6 Couplers, Gardena Blister Pack	1
10	Gardena40892 0	TBD	2 Connectors+6 Couplers, Gardena Blister Pack	1
10	579 04 81-01	TILLBEHÖRSPÅSE	5 Connectors+5 Couplers	1
11	586 27 79-01	ETIKETT	Sticker, Cable Markers (10 pcs)	1
12	502 40 53-01	DEKAL	Label, Anti-Theft	1
13	578 90 91-05	DVD	Installation DVD, Gardena	1
14	115844301	TBD	Operator's Manual, Swedish	1
14	115844306	TBD	Operator's Manual, Danish	1
14	115844311	TBD	Operator's Manual, Finnish	1
14	115844321	TBD	Operator's Manual, Norwegian	1
14	115844326	TBD	Operator's Manual, English	1
14	115844331	TBD	Operator's Manual, French	1
14	115844336	TBD	Operator's Manual, Dutch	1
14	115844341	TBD	Operator's Manual, Italian	1
14	115844346	TBD	Operator's Manual, Spanish	1
14	115844351	TBD	Operator's Manual, German	1
14	115844358	TBD	Operator's Manual, Hungarian	1
14	115844359	TBD	Operator's Manual, Portuguese	1
14	115844361	TBD	Operator's Manual, Polish	1
14	115844368	TBD	Operator's Manual, Slovakian	1
14	115844384	TBD	Operator's Manual, Slovenian	1
14	115844390	TBD	Operator's Manual, Czech	1
15	115 84 37-01	QUICK GUIDE	Quick Guide, Swedish	1

Ref	Artikelnr	Beskrivning	Anmärkning	ANT SATS AL
15	115843706	TBD	Quick Guide, Danish	1
15	115843711	TBD	Quick Guide, Finnish	1
15	115843721	TBD	Quick Guide, Norwegian	1
15	115843726	TBD	Quick Guide, English	1
15	115843731	TBD	Quick Guide, French	1
15	115843736	TBD	Quick Guide, Dutch	1
15	115843741	TBD	Quick Guide, Italian	1
15	115843746	TBD	Quick Guide, Spanish	1
15	115843751	TBD	Quick Guide, German	1
15	115843758	TBD	Quick Guide, Hungarian	1
15	115843759	TBD	Quick Guide, Portuguese	1
15	115843761	TBD	Quick Guide, Polish	1
15	115843768	TBD	Quick Guide, Slovakian	1
15	115843784	TBD	Quick Guide, Slovenian	1
15	115843790	TBD	Quick Guide, Czech	1
16	967 10 49-01	REPARATIONSSATS	Boundary repair kit, 5m boundary wire, 6x connectors, 10x staples	1
16	Gardena40592 0	TBD	Boundary repair kit, 5m boundary wire, 6x connectors, 10x staples	1

G GARDENA R38Li/40Li/R45Li/R50Li
ACCESSORIES

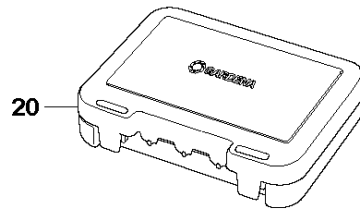
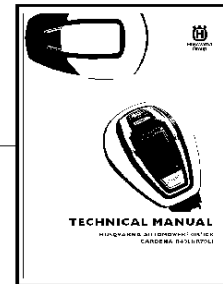
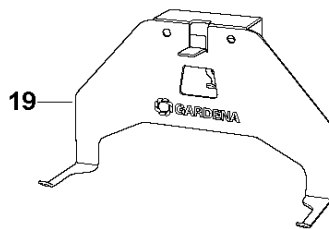
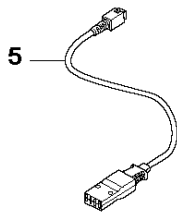
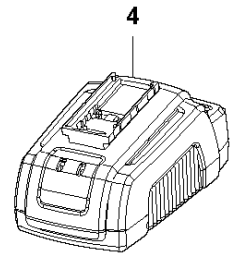
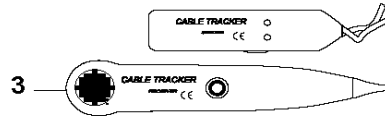
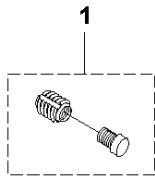

18

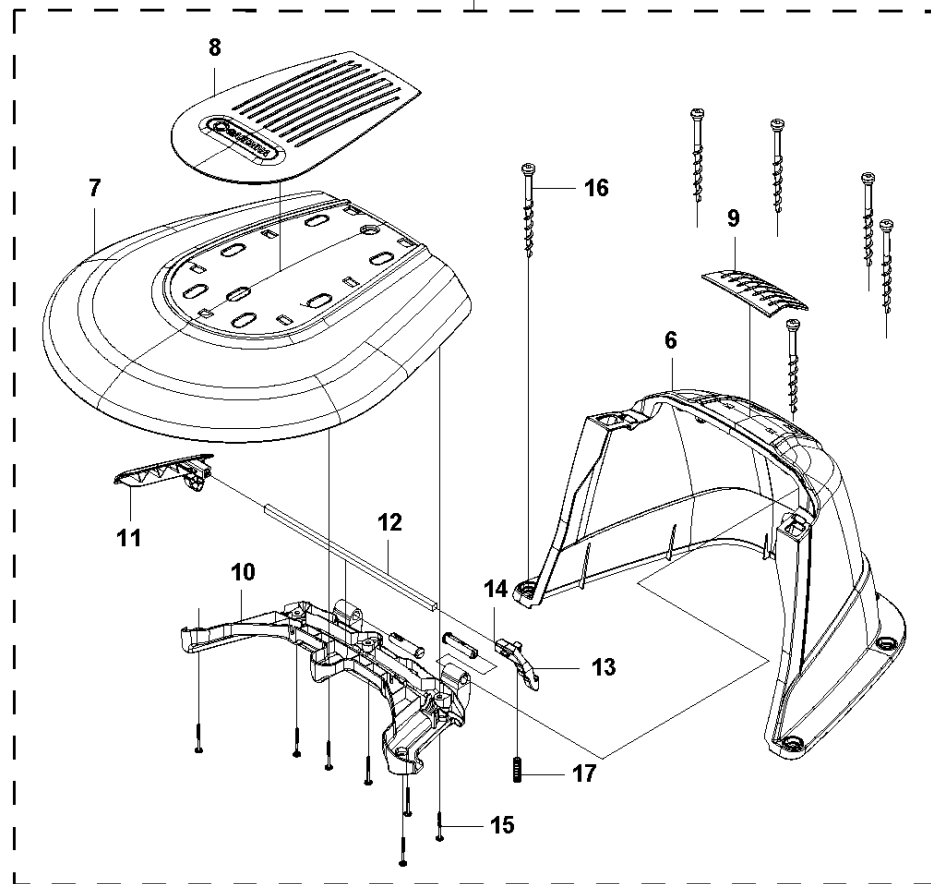

Ref	Artikelnr	Beskrivning	Anmärkning	ANT SATS AL
1	581 16 57-01	GÄNGINSATS	Metal Insert Repair KIT (4 pcs)	1
2	580 68 95-02	DEKAL	Warranty Seal 1pcs	1
3	577 60 68-01	TESTUTRUSTNING	Loop Wire Interruption Detector	1
4	588 40 84-01	LADDARE	Quick Charger with Battery Test	1
5	588 20 26-01	KABLAGE KPL	Cable Quick Charger	1
6	587 91 63-01	TÄCKLOCKSSATS	Cover KIT Base	1
7	587 91 64-01	TÄCKLOCKSSATS	Cover KIT Lid	1
8	586 69 44-01	KÅPA	Cover Front Insert	1
9	586 69 46-01	KÅPA	Cover Rear Insert	1
10	586 69 42-01	BALK	Beam Hinge	1
11	586 69 47-01	HANDTAG	Handle Left	1
12	585 32 41-02	STÅNG	Steel Rod	1
13	586 69 48-01	SPÄRRHAKE	Latch Right	1
14	585 34 15-01	GÄNGJÄRNSPINNE	Hinge Pin	2
15	575 54 33-14	SCREW	Screw	8
16	575 23 86-01	SCREW KIT	Screw KIT	1
17	580 51 14-01	FJÄDER	Spring Cap	1
18	586 80 17-01	HUS	Gardena Housing	1
19	967 10 46-01	WALL HANGER	WALL HANGER	1
19	Gardena404220	TBD	WALL HANGER	1
20	967 10 45-01	KOPPLING	Cable Connector Protection	1
20	Gardena405620	TBD	Cable Connector Protection	1
21	115 44 50-01	VERKSTADSHANDBOK	TECHNICAL MANUAL, Swedish	1
21	115 44 50-06	VERKSTADSHANDBOK	TECHNICAL MANUAL, Danish	1
21	115 44 50-11	VERKSTADSHANDBOK	TECHNICAL MANUAL, Finnish	1
21	115 44 50-21	VERKSTADSHANDBOK	TECHNICAL MANUAL, Norwegian	1
21	115 44 50-26	VERKSTADSHANDBOK	TECHNICAL MANUAL, English	1
21	115 44 50-31	VERKSTADSHANDBOK	TECHNICAL MANUAL, French	1
21	115 44 50-36	VERKSTADSHANDBOK	TECHNICAL MANUAL, Dutch	1
21	115 44 50-41	VERKSTADSHANDBOK	TECHNICAL MANUAL, Italian	1
21	115 44 50-46	VERKSTADSHANDBOK	TECHNICAL MANUAL, Spanish	1
21	115 44 50-51	VERKSTADSHANDBOK	TECHNICAL MANUAL, German	1
21	115 44 50-56	VERKSTADSHANDBOK	TECHNICAL MANUAL, Russian	1
21	115 44 50-58	VERKSTADSHANDBOK	TECHNICAL MANUAL, Hungarian	1
21	115 44 50-61	VERKSTADSHANDBOK	TECHNICAL MANUAL, Polish	1
21	115 44 50-62	VERKSTADSHANDBOK	TECHNICAL MANUAL, Romanian	1
21	115 44 50-63	VERKSTADSHANDBOK	TECHNICAL MANUAL, Estonian	1
21	115 44 50-64	VERKSTADSHANDBOK	TECHNICAL MANUAL, Latvian	1
21	115 44 50-65	VERKSTADSHANDBOK	TECHNICAL MANUAL, Lithuanian	1
21	115 44 50-71	VERKSTADSHANDBOK	TECHNICAL MANUAL, Greek	1
21	115 44 50-76	VERKSTADSHANDBOK	TECHNICAL MANUAL, Turkish	1
21	115 44 50-81	VERKSTADSHANDBOK	TECHNICAL MANUAL, Croatian	1
21	115 44 50-90	VERKSTADSHANDBOK	TECHNICAL MANUAL, Czech	1